

UNIT:MM

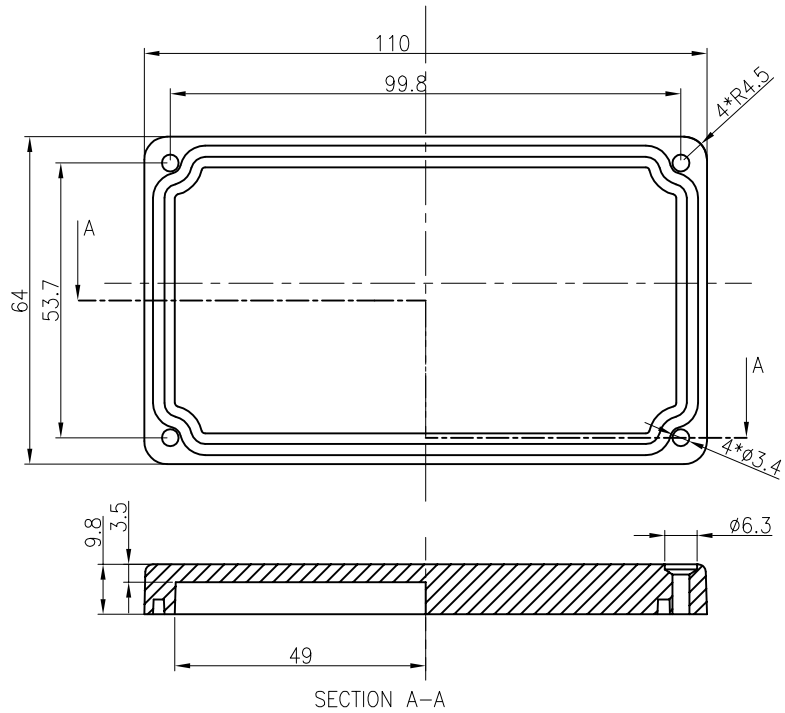

SECTION A-A

DRAWN:	WEIGHT:	TITLE: FA7 ALUMINUMALLOY Waterproof Enclosure	PART. NO. : FA7-1
CHECKED:	SCALE: 1:1	DWG. NO: FA7	Ningbo Zhongkai Enclosure CO.,LTD
ENG APPR:	MATERIAL: AL	SHEET 1 OF 1	
MFG APPR:	DATA:		

UNIT:MM

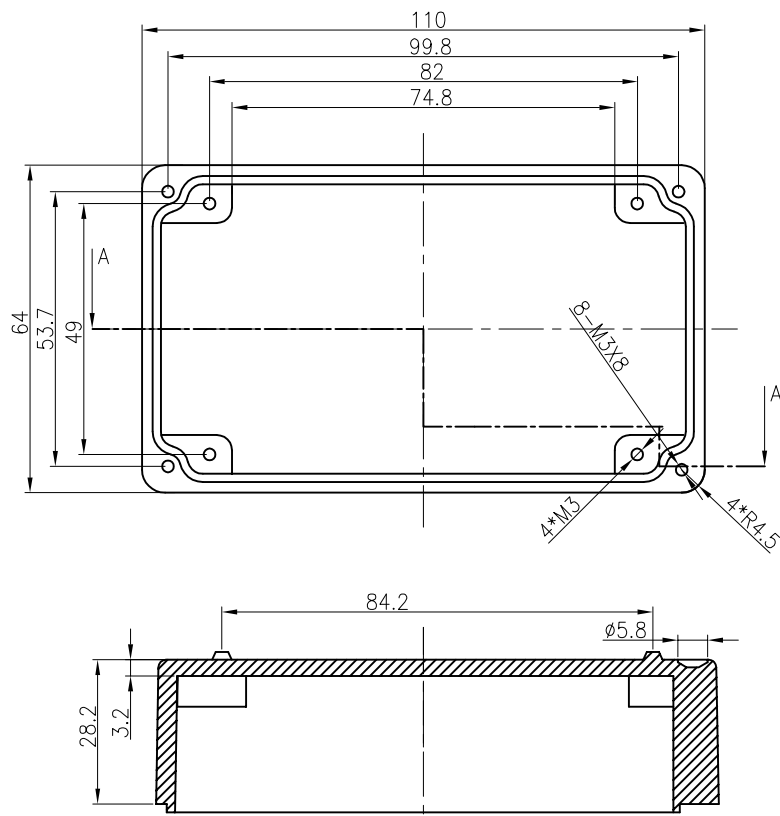

SECTION A-A

DRAWN:	WEIGHT:	TITLE: FA7 ALUMINUMALLOY Waterproof Enclosure	PART. NO. : FA7-2
CHECKED:	SCALE: 1:1	DWG. NO: FA7	Ningbo Zhongkai Enclosure CO.,LTD
ENG APPR:	MATERIAL: AL	SHEET 1 OF 1	
MFG APPR:	DATA:		